

---

# Journal of Engineering Technology and Applied Physics

---

## Revolutionizing Connectivity: The Breakthrough of Batteryless Mouse Using Magnetic Resonant Coupling for Communication Devices

Lin Lin Han, Chia Chao Kang\*, Jian Ding Tan, Mohammadmahdi Ariannejad, Steven Yong Choong Hong and Ming Yam Chua

*School of Electrical Engineering and Artificial Intelligence, Xiamen University Malaysia, Sepang, Selangor, Malaysia.*

\*Corresponding author: [chiachao.kang@xmu.edu.my](mailto:chiachao.kang@xmu.edu.my), ORCID: 0000-0002-8716-3739

<https://doi.org/10.33093/jetap.2023.5.2.11>

Manuscript Received: 23 June 2023, Accepted: 23 July 2023, Published: 15 September 2023

**Abstract** — With the rapid development of electronic technology and information technology, personal computer has gradually become the public's office or entertainment tools, which also makes the computer mouse a widely used tool. However, most computer mouse on the market today come with batteries. In this context, it is necessary to design a batteryless mouse that without using power supply such as battery. In view of such demand, on the basic of theoretical analysis, this paper summarizes and designs a classical wireless transmission structure – magnetic resonant coupling and antenna that used to transmit and received power for communication devices. In order to understand the operation of wireless power transmission technology, the paper analysed antenna construction and wireless power transmission technology. The basic design parameters of the axial mode helical antenna structure are also explained. Finally, by using CST STUDIO software, axial mode helical antenna with gain of 6.45 dBi was obtained. The system's output voltage is successfully simulated at 1.516 V that can powered up the computer mouse.

**Keywords**—Magnetically-Coupled Resonant, Wireless Power Transfer, Batteryless Mouse

### I. INTRODUCTION

Wireless power transfer (WPT) is the transmission of electrical energy without cable as a physical link. In a wireless power transmission system, a transmitter device, driven by electric power from a power source, generates a time-varying electromagnetic field, which

transmits power across space to a receiver device. Therefore, WPT has the advantages of safety, reliability, good flexibility and strong environmental adaptability. Based on the advantages of WPT, this technology can be used in all aspects of people's life, even in the ocean and space. In medical devices, for example, implantable pacemakers based on the technology could protect patients from secondary injuries caused by a spent battery. In the case of portable electronics, advantages such as fewer plugs and better appearance are among the benefits of WPT. WPT technology has developed rapidly over the past century. According to the different working principles, WPT technology can be roughly divided into four types: inductive coupled, magnetic resonance, microwave power and laser power [1]. Power transmission via microwaves technology and laser technology allowing longer- distance power beaming. Inductive or magnetic coupling WPT can be used for the portable and mobile devices. Portable electronic devices using WPT often rely on the transmitter coil in the charging device and the receiver coil in the electronic device. The distance between the two coils is the distance between the charging device and the electronics. The design of WPT may have some shortcomings resulting in short transmission distance. Magnetic coupling resonant transfer can solve this problem.

In recent years, due to the growth of the global economy and changes in production methods, more and more people have computers. And with the

popularity of computers, mouse sales also began to grow rapidly. Meanwhile, every general mouse comes with a USB cable that connects to computer. Most wireless mouse today is powered by a lithium-ion battery (LIB). Lithium-ion batteries are harmful to the environment. Many types of batteries currently end up in landfills or incinerators. Although spent lithium-ion batteries can be recycled and reused, small LIB needs to be returned by customers through battery collection points. Due to ignorance of the collection system, small used LIB are likely to be thrown directly into the general waste bin. Because of the difference in the way spent LIBs are transported and recycled, destructive fires can occur during transportation or recycling if waste LIBs are treated as normal garbage. Landfill and incineration of LIB are also risky. Buried LIBs, which may be holding a charge and contain flammable electrolytes, may trigger, amplify and prolong landfill fires. The Environmental Services Association (ESA), the trade body representing the UK's resource and waste management industry, reported that 25% of total landfill fires in the UK in the period 2017–18, were attributed to LIBs: a significant 20% increase in comparison to the previous year [2]. Landfill fires do not only affect the air around the site as the smoke can carry particulate matter and chemicals to further distances: for example, it has been shown that there may be a short term rise in the concentrations of heavy metals and Chemical Oxygen Demand (COD) or PAHs86 in water bodies next to burning sites. In addition, LIB contains a lot of heavy metals. If the battery leaks onto open ground, heavy metals can flow into nearby rivers or lakes with rain, causing biological and environmental hazards. Heavy metals in LIBs include lithium, cobalt, nickel, manganese, iron, chromium and copper. Toxicity of heavy metals includes attachment, blocking, and disruption of conformational structures of carbohydrates, lipids, proteins, or enzymes. Nickel is the most common allergic metal in terms of human health. It can also cause respiratory problems and even cancer at higher concentrations.

Therefore, this paper decides to design a batteryless mouse via magnetic resonant coupling for communication devices. When the transmission system and the receiving system work at the same frequency, the electricity transmitted through the transformer circuit composed of inductor to achieve electromagnetic conversion, through the air to the receiving end of the load for use, so as to achieve wireless charging for the mouse. And the capacitors can make the circuit in a resonant state to save power and make the transmission distance longer.

## II. LITERATURE REVIEW

### A. MCR-WPT System

The history of radio energy transmission (WPT) is as early as the 1890s, Nikola Tesla, a Serbian scientist, put forward a bold idea: Take the earth as a huge inner conductor and the ionosphere as the outer conductor, and build a very large machine as the transmitter. The machine can generate oscillating electromagnetic

waves, which continue to resonate at a lower frequency in the ionosphere of the earth, and use of electromagnetic waves around the earth to transport energy [3]. The bold idea was theoretically proven to be almost 100% efficient, but the technical requirements were so stringent that the project had to be halted.

Over the past century, WPT technology has developed rapidly and can be roughly subdivided into three types according to their working principles: induction radio energy transmission, microwave radiation radio energy transmission and magnetically coupled resonant radio energy transmission [4]. Article describes a high-frequency, low-power device-compatible magnetic-coupled resonant radio energy transmission technique (MCR-WPT). Specifically, when the operating frequency of the transmitting system and the receiving system is the same, the transmitted electric energy passes through the oscillation circuit composed of inductors and capacitors to achieve electromagnetic conversion, and then passes through the air to the receiving end for load use. MCR-WPT is a kind of radio energy transmission mode suitable for daily life and specific precision because it has the characteristics of long-distance transmission and high efficiency.

The development of radio Energy Transmission (WPT) technology has led to advances in wireless communications, electric vehicles, medical devices, and service robots. At the same time, these fields put forward higher requirements for radio energy transmission system. Among the pressing issues is how to transmit power over a larger space so that receiving devices can receive it without limit. Similarly, a radio-powered mouse would need to be able to move over a larger area of space. This requires the launch system to generate an omni-directional, uniform magnetic field so that the device can be moved or rotated during use without the need to precisely position or align the device with the launch system. Among them, in 2017, Chabalko team in the United States designed a WPT device based on electromagnetic resonant cavity [5] in Fig. 1.

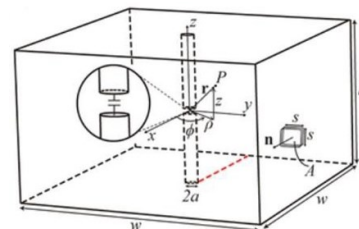

Fig. 1. WPT device based on Electromagnetic Resonant Cavity [5].

The device uses the natural electromagnetic properties of the hollow metal structure to generate a uniform magnetic field, which can simultaneously power a small receiver inside with an efficiency of more than 50% [5].

With the maturity of infinite power transmission technology, the transmission range and spatial freedom of WPT are paid more and more attention by scholars. For WPT systems, Professor Udaya K. Madawala has also proposed a novel series hybrid topology that provides constant power transmission over a wide range of spatial displacements [6] in Fig. 2.

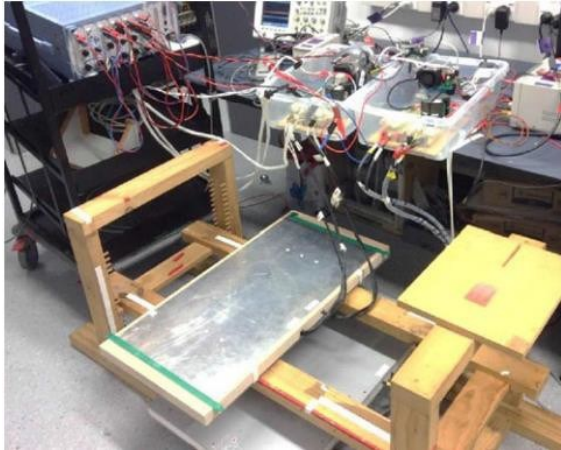

Fig. 2. Experimental setup of the 3.3kW prototype [6].

However, planar WPT technology is difficult to deal with Angle rotation and position migration in a wide range. The mouse has higher mobility requirements, so these flat WPT technologies are not suitable.

In 2019, J H Kim proposed a new receiving coil structure, which requires only two coils to achieve omni-directional wireless power transmission of any type of transmitter [7]. This is shown in the Fig. 3.

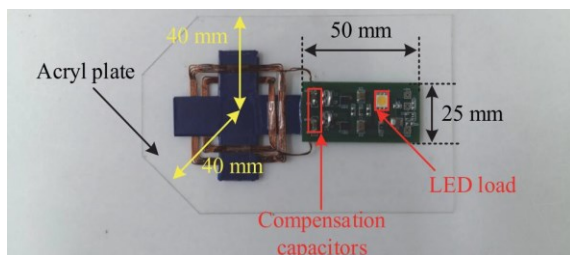

Fig. 3. Rx coil prototype connected to an Rx circuit fabricated on a PCB with a phone-sized board [7].

Each coil contains a cross-shaped ferrite core with each stand intersecting two coils. When a coil is rotated  $90^\circ$ , its ferritic core intersects in the same direction as the other coil, which verifies that at least one coil will generate voltage in any direction of flux, and the high-quality factor of the coil can also ensure the omni directivity of the system. In the experiment, the receiving coil is connected in series with the light-emitting diode, which is always in working state regardless of the attitude of the receiver within a certain range.

### B. Design of Miniaturization of Antenna

#### (a) Loading technology

In the design of a small antenna, if the electrical length of the antenna is much smaller than the free space half wavelength, the input resistance is generally small but the reactance is large, which makes it particularly difficult to match the load. However, the introduction of loading technology can effectively improve the current distribution on the antenna surface and achieve the effect of impedance compensation [8]. It is realized by inserting elements such as resistance, capacitance and inductance into the appropriate position of the antenna. Wang introduced a way to realize the miniaturization of monopole antenna by combining multiple loads, so that it has a small size while ensuring a large working bandwidth, but the introduction of lossable resistance makes its working efficiency low [9]. The purpose of miniaturization can also be achieved by loading antennas with different media materials [10]. However, due to the influence of dielectric resonance effect, the impedance characteristics of the antenna loaded with high dielectric constant material will deteriorate to a certain extent, resulting in a narrower working frequency band and often accompanied by high dielectric loss, reducing the radiation efficiency of the antenna. In addition, adopting short-circuit technology [11], bending or grooving the antenna surface, and adding ground floor according to the mirror principle are also common methods for antenna loading.

#### (b) Medium substrate with special material

The introduction of substrate with high dielectric constant or high permeability is a common method to realize the miniaturization design of microstrip antenna and printed antenna [12]. However, this kind of high order quality antenna also has some defects, such as high cost, large surface loss, low gain, narrow working bandwidth and so on [13]. Farzami introduced a miniaturization design scheme of microstrip antenna loaded with magnetic medium substrate [14]. The specific structure is shown in Fig. 4.

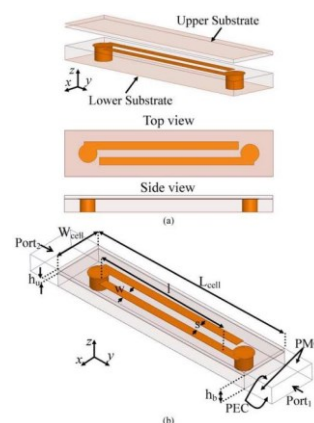

Fig. 4. Microstrip Antenna using Magnetic Medium Substrate [14].

It designs a 2.4 GHz microstrip antenna on a dielectric substrate with a relative dielectric constant of 6 and a relative permeability of 2, and successfully changes the antenna size to one third of that of a

traditional dielectric substrate microstrip antenna, but its gain and radiation efficiency are relatively reduced.

### (c) Optimize the shape structure of the antenna

The general idea of using this method to achieve antenna miniaturization design is to make the effective length of the antenna greater than its physical length, that is, to reduce the volume of space occupied by the antenna while keeping the basic performance unchanged through reasonable structural design, so as to achieve miniaturization [15]. One of the most typical and popular schemes is the use of fractal structure. At present, fractal curves are mainly used by Koch, Minkowski, Hlibert and Peano. Jaume Anguera proposed a design of miniaturized monopole antenna using Hilbert fractal curve, whose structure is shown in Fig. 5.

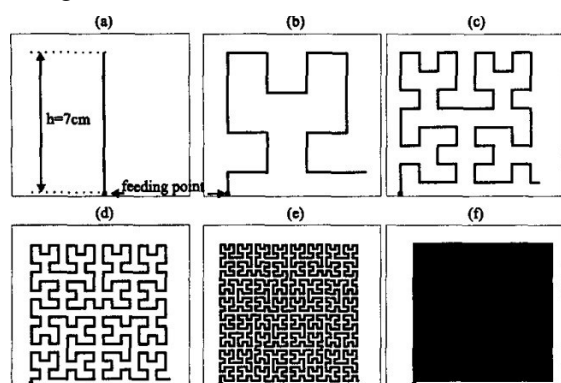

Fig. 5. Monopole Antenna Based on Hilbert Fractal Curve [16].

In addition, a large number of other structural research schemes have been proposed in recent years, such as cascading short-circuit patch [17], inverted F-shape [18], L-shape [19], E-shape structure [20] and so on.

### C. Description of Helical Antenna

The spiral antenna was first proposed in 1946 by J. D. Kraus, a scholar from Ohio State University. There are two operating modes of helical antenna: normal mode and axial mode. It is a kind of traveling wave antenna, which is often used in meter wave and decimeter wave band. This antenna not only can be used alone, but also can be array or nested combination of different frequency band antennas. It can also be used as the irradiation source of reflector antenna. The structure of helical antenna is relatively simple, the radial array makes it can be used in the communication system with high gain requirements, and because it can be reused and nested in the axis, it can be used in the communication system of multi-frequency transceiver.

In summary the research concentrates on reviewing MCR-WPT, which combines diverse substrates and specific materials to accomplish high-frequency, low-power magnetic-coupled resonant transmission. Finally, optimizing form structures, including fractal designs, are investigated to achieve different antenna use. In addition, the helical antenna is frequently employed in microwave bands and functions in normal and axial modes. It has high gain

and multi-frequency transceiver capabilities and may be used individually or in arrays.

## III. MATERIALS AND METHOD

### A. Resonance Structure

The resonant circuit structure is in two coil structure. Because of the resonant capacitor in the transmitting loop and receiving loop, it can exist in the circuit in series or parallel. Then the transmitting loop and receiving loop and capacitor can form four different resonant structures: Serial-Series (SS), serial-Parallel (SP), Parallel-Series (PS) and Parallel-Parallel (PP), as shown in Fig. 6.

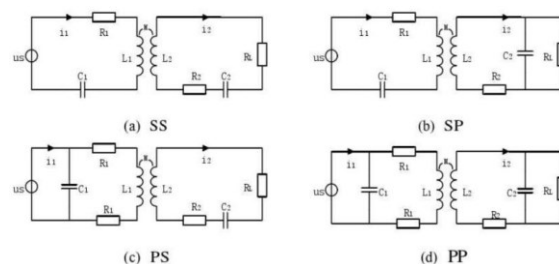

Fig. 6. Resonant Structures of (a) Serial-Series (SS), (b) Serial-Parallel (SP), (c) Parallel-Series (PS) and (d) Parallel-Parallel (PP) [21].

When the system is PS or PP structure, the resonant capacitance will change with the change of load. When the system is SS or SP structure, the value of resonant capacitance does not change with the change of load. Considering the stability of the whole system, the paper decided to abandon the PS and PP structure. For SS structure and SP structure, SP structure has the characteristic of constant voltage output, its output is independent of the change of load and coupling relationship, which can ensure that the input end of the power supply has a constant power factor. But when the load resistance value is small, SS structure can achieve the optimal impedance matching. And when the system frequency is in kHz-MHz, the transmission efficiency of SS structure is higher than that of SP structure. Another important point is that the charging target of this product is the mouse, so there is no need to consider the change of load on the output power [21]. Then the paper decided to choose the SS structure.

### B. Load Rectifier Filter Circuit

Since the transmitting coil is connected to high-frequency AC, the receiving coil is also connected to AC, which can only be transmitted to the load after rectification and filtering. The function of the rectifying circuit is to convert alternating current from the receiving coil to direct current. The function of filter circuit is to filter the clutter in DC current and output stable DC current. The stable direct current output can activate the mouse directly. The rectifier circuit used will be the bridge rectifier circuit. This rectifier circuit uses a common transformer, but uses two more rectifier diodes than full-wave rectifier.



Since four rectifier diodes are connected in bridge form, this rectifier circuit is called bridge rectifier circuit.

After the AC is rectified, the pulsating DC power supply can't be directly used as the power supply for electronic circuits due to the large AC ripple. The filter circuit can greatly reduce the ac ripple component, so that the voltage waveform after rectification becomes relatively smooth. The common filter circuit includes capacitance filter circuit, inductance filter circuit, RC filter circuit, LC filter circuit and active filter circuit. The LM317 is a three-terminal adjustable positively-stabilized integrated circuit from National Semiconductor Corporation. According to the usage report of LM317, its output voltage range is 1.2 V to 37 V, and the maximum load current is 1.5A, which is in line with the requirements of the MCR-WPT designed in this project. In addition, it is very simple to use, only two external resistors to set the output voltage. It also has a better linear adjustment rate and load adjustment rate than standard fixed regulators. The LM317 has built-in protection circuits such as overload protection and safety zone protection. A much higher ripple rejection ratio can be obtained by using the filter capacitor at the regulating end than the standard three-terminal regulator. The standard application from Texas Instruments is shown in Fig. 7.

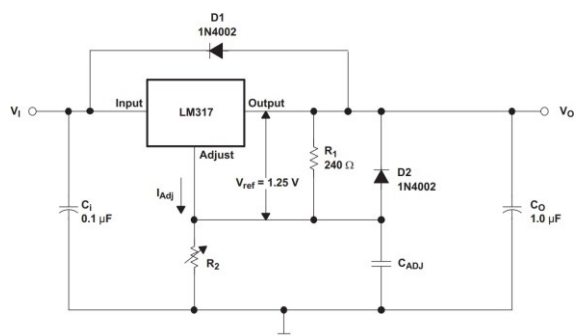

Fig. 7. Adjustable Voltage Regulator.

This is an adjustable voltage regulator, that its structure can be adjusted to get the desired output voltage. The output voltage is determined by two external resistors  $R_1$  and  $R_2$ . In this paper, only  $R_1$  and  $R_2$  are needed to obtain the required 1.5V voltage regulator.

C. Antenna

A typical axial mode spiral antenna is designed in this paper. the basic structure of the spiral antenna is shown in Fig. 8, where  $D$  is the diameter of the spiral and its range is  $0.2 \lambda < a < 0.5 \lambda$ ,  $S$  is the spacing, and its maximum length should not exceed 0.5 wavelength,  $L$  is the circumference of a spiral circle, and  $\alpha$  is the pitch angle [22]. When  $D$  of the designed helix is fixed, reduce the spacing  $S$  to zero, the pitch angle  $\alpha$  will also become zero and the helix collapses to a loop. On the others hand, when  $S$  is fixed,  $D$  is reduced to zero, the pitch angle  $\alpha$  will become  $90^\circ$  which means the helix straightens out into linear conductor. In order to better understand the relations between  $S$ ,

$D$ , and  $\alpha$ ,  $D$ - $S$  chart are shown in a particularly convenient way as in Fig. 9 which is invented by John Kraus.

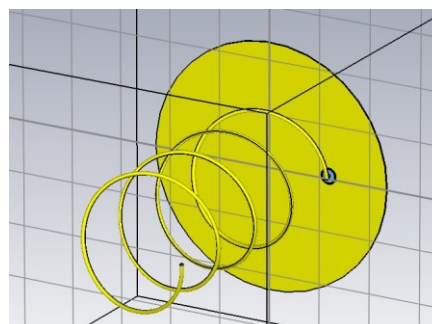

Fig. 8. Structure of designed Helical Antenna.

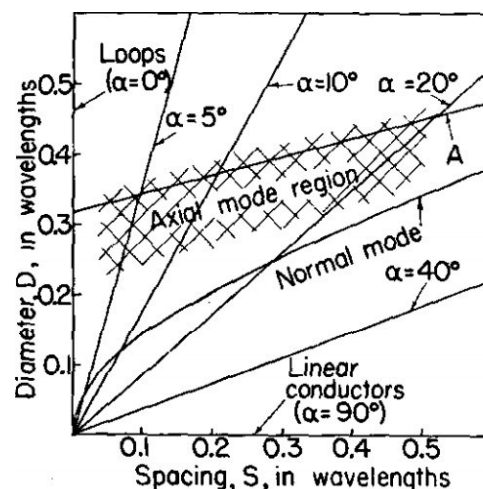

Fig. 9. Diameter-spacing Chart [22].

The figure is divided into three parts: the lower part is the normal mode helical antenna area; The upper part is the conical direction helical antenna; The shaded part in the middle is the axial mode helical antenna region. Since the axial mode helical antenna is designed in this project, the ratio of the pitch and the diameter of the helical structure to the wavelength should be chosen in the middle region. At the same time, in order to meet the requirements of practical application, the antenna size should not be designed to be too large.

Setting the frequency as 2.4 GHz, the wavelength can be obtained as 125 mm using Eq. (1).

$$\lambda = \frac{c}{f} = \frac{3 \times 10^8 \text{ m/s}}{2.4 \times 10^9 \text{ Hz}} = 125 \text{ mm} \quad (1)$$

Selecting values in the middle region of the Diameter-spacing chart, the diameter of the helical structure can be calculated as shown in Eq. (2).

$$D = 0.37\lambda = 0.37 \times 125 \text{ mm} = 46.25 \text{ mm} \quad (2)$$

Similarly, the spacing of the helical structure of the antenna can be set as,

$$S = 0.2\lambda = 0.2 \times 125 \text{ mm} = 25 \text{ mm}$$

Table I shows the detailed parameters of the designed helical antenna:

Table I: Parameters of the designed helical antenna.

Description	Value
Diameter of the helical structure (D)	46.25 mm
Diameter of ground	92.5 mm
Length of coaxial conductor	5.0 mm
Turns	4
Spacing (S)	25 mm
Radius of the helical conductor	0.7 mm
Inner conductor radius	0.7 mm
Radius of medium	2.5 mm
Height of the helical antenna	103.5 mm

The antenna is made of copper and vacuum. The antenna is roughly composed of helical conductor, ground, coaxial conductor three parts. The antenna's helical conductor, the inner and outer conductors of the coaxial conductor and the ground are all made of copper, and the medium of the coaxial conductor is vacuum material.

*D. Antenna Transmitting Part*

The electromagnetic resonance wireless power transfer method is used to design the transmitter to transmit energy and received by the mouse. The main structure of the transmitter includes the transmitter, the transmission antenna and the receiver. The computer can provide a voltage of 5 V and wireless mouse charging requires voltage of 1.5 V, if voltage of 1.5 V is detected in the receiver part with the using of helical antenna and rectifier, the transmission circuit part is simulated successfully.

IV. RESULTS

*A. Antenna Simulation*

End-fire helical antenna refers to the antenna where the electromagnetic wave propagates along the antenna structure and produces the maximum radiation in the direction of propagation. Figure 10 and Fig. 11 show the propagation energy of the designed antenna. It can be clearly seen that the energy propagated by the designed antenna is along the direction of the antenna structure. Therefore, in terms of directivity, the designed antenna meets the requirement.

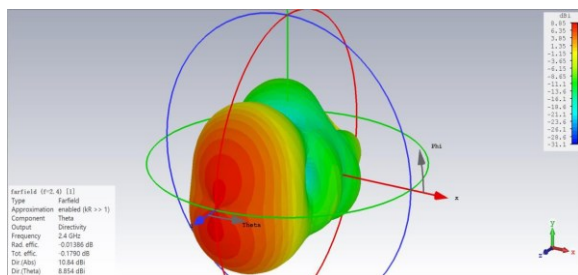

Fig. 10. Propagation energy of the designed antenna (Theta).

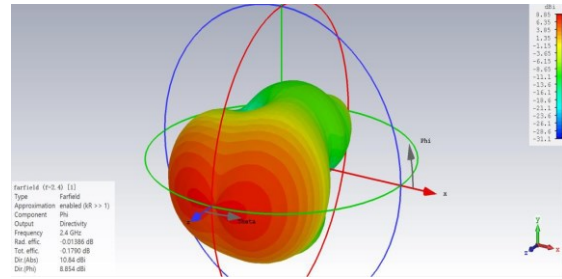

Fig. 11. Propagation energy of the designed antenna (Phi).

Figure 12 shows the simulated results of the designed antenna in the phi component theta component and absolute case respectively. As can be seen from the figure, the main lobe magnitude is 6.54 dBi, which reflects and accords with the high gain of end-fire antenna. The higher the gain, and the narrow the main lobe, the antenna will radiate power more intensively and thus receives power intensively, which means that more energy transmitted can be absorbed by the receiver connected to the mouse, improving the efficiency of the antenna's power transmission.

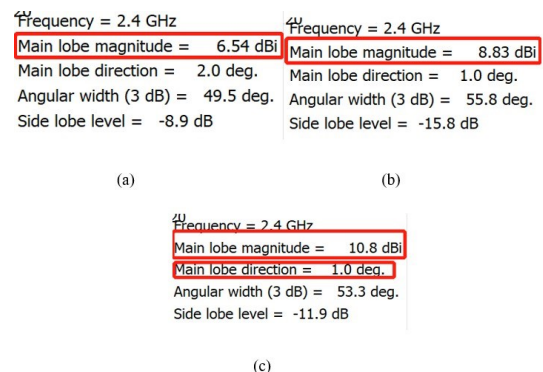

Fig. 12. Simulated Results of the Designed Antenna. (a) Result in the phi Component, (b) Result in the theta Component and (c) Absolute Case.

For antennas operating at 2.4 GHz, the following requirements are usually achieved: First, return loss needs to be less than or equal to -10 dB and is expected to reach its lowest point at 2.4 GHz, as this means that the antenna will reach its maximum gain at this time. Figure 13 below show the return loss of the designed antenna at 2.4 GHz and the lowest point respectively.

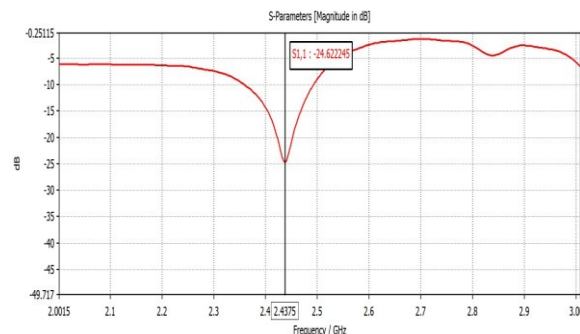

Fig. 13. Return loss of the designed antenna at the lowest point.

The antenna designed to reach the return loss of the lowest point is about  $-24.62$  dB, which is far less than the return loss of qualified antenna generally required, that is, far less than  $-10$  dB. This means that more than 90% of the signal is radiated and only 10% of the signal is reflected [23], that is to say when the frequency is 2.4 GHz, the return loss also meets the requirements of qualified antenna.

### B. MCR-WPT System Simulation

The following is the resonant circuit of the transmitting part, where AC source that provides  $V_{pp}$  of 5 V and 2.4 GHz in Fig. 14.

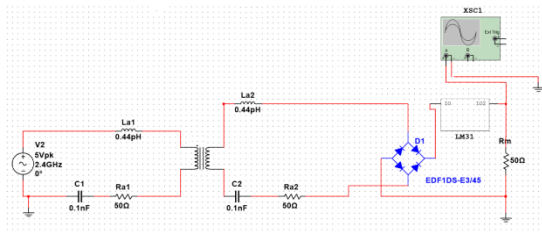

Fig. 14. System block diagram.

The left work as the antenna at the transmitting end, while the right part work as the antenna at the receiving end. The electromagnetic resonance wireless power transfer principle works similarly to the component transfer principle, the two antennas used for radio energy transmission in the simulation are simplified to a 1:1 ratio. It can deliver stable power to the mouse instead of batteries. LM317 use as adjustable regulator to provide necessary output. Based on simulation, when the system runs for a period of time, the voltage of the output resistance will stabilize at 1.516 V. This shows that the antenna receiver circuit can supply a steady voltage of about 1.5 V to the computer mouse. Therefore, the circuit design in this project is successfully.

### V. CONCLUSION

The paper analyses research on wireless transmission technology and design on the antenna structure to understand the working principle of wireless transmission technology. The basic design parameters of the axial-mode helical antenna structure and the relationship between each parameter such as gain, directivity and return loss are also explained. Finally, this project designs an axial-mode helical antenna with gain of 6.54 dBi and height of 10.35 cm by using CST software. Finally, the output voltage of the system was successfully detected to be stable at 1.516 V. One of the limitations of the study was magnetic resonant coupling can susceptible to interference from nearby metallic objects or other electronic devices that operating on the similar frequencies. Thus, it will lead to reduce the performance issues for the mouse. The future research direction will develop algorithms and techniques that enable the magnetic resonant coupling system to dynamically adjust its operating frequency based on the surrounding electromagnetic environment. This adaptive approach can help the system find a less

crowded frequency band and avoid interference from other devices.

### ACKNOWLEDGEMENT

The authors would like to express their gratitude to the Ministry of Higher Education Malaysia for the support provided for the study under the Fundamental Research Grant Scheme: FRGS/1/2022 TK08/XMU/02/10 and Xiamen University Malaysia under Research Fund Grant No: XMUMRF/2021-C7/IECE/0018 and XMUMRF/2023-C12/IECE/0047.

### REFERENCES

- [1] C. Raja, M. Ramachandran and M. Selvam, "Opportunities and Challenges for Wireless Power Transfer System," *J. Appl. and Chem. Phys.*, vol. 1, no. 1, pp. 14–21, 2022.
- [2] W. Mroziak, M. A. Rajaeifar, O. Heidrich and P. Christensen, "Environmental Impacts, Pollution Sources and Pathways of Spent Lithium-ion Batteries," *Energy & Environ. Sci.*, vol. 14, no. 12, pp. 6099–6121, 2021.
- [3] A. Kurs, A. Karalis, R. Moffatt, J. D. Joannopoulos, P. Fisher and M. Soljacic, "Wireless Power Transfer via Strongly Coupled Magnetic Resonances," *Science*, vol. 317, no. 5834, pp. 83–86, 2007.
- [4] K. Zhang, Z. Zhu and B. Song, "A Power Distribution Model of Magnetic Resonance WPT System in Seawater," in *IEEE 2nd Annual Southern Power Electronics Conf.*, pp. 1–4, New Zealand, 2016.
- [5] M. J. Chabalko, M. Shahmohammadi and A. P. Sample, "Quasistatic Cavity Resonance for Ubiquitous Wireless Power Transfer," *PLoS ONE*, vol. 12, no. 2, pp. e0169045, 2017.
- [6] L. Zhao, D. J. Thrimawithana and U. K. Madawala, "Hybrid Bidirectional Wireless EV Charging System Tolerant to Pad Misalignment," *IEEE Trans. Indust. Electron.*, vol. 64, no. 9, pp. 7079–7086, 2017.
- [7] J. H. Kim, B. G. Choi, S. Y. Jeong, S. H. Han, H. R. Kim, C. T. Rim and Y. S. Kim, "Plane-Type Receiving Coil With Minimum Number of Coils for Omnidirectional Wireless Power Transfer," *IEEE Trans. Power Electron.*, vol. 35, no. 6, pp. 6165–6174, 2020.
- [8] D. Chen, W. Yang, W. Che and Q. Xue, "Miniaturized Wideband Metasurface Antennas Using Cross-layer Capacitive Loading," *IEEE Antennas and Wireless Propag. Lett.*, vol. 21, no. 1, pp. 19–23, 2022.
- [9] Z. Wang, Y. Liu, Y. Wei and Y. Song, "Study on Electromagnetic Characteristics of The Magnetic Coupling Resonant Coil for The Wireless Power Transmission System," *J. Appl. Biomater. & Function. Mater.*, vol. 16 (Supp\_1), pp. 140–149, 2018.
- [10] S. Chaimool, A. Pinsakul and P. Akkaraekthalin, "Patch Antenna Miniaturization Using Artificial Magneto-dielectric Metasubstrate," in *Int. Symp. Antennas and Propag.*, pp. 906–909, 2012.
- [11] T. Fujimoto, "Wideband Stacked Square Microstrip Antenna with Shorting Plates," *IEICE Trans. Communications*, vol. E91-B, no. 5, pp. 1669–1672, 2008.
- [12] T. Inui, H. Koga, M. Nogi, N. Komoda and K. Suganuma, "A Miniaturized Flexible Antenna Printed on A High Dielectric Constant Nanopaper Composite," *Advanced Materials*, vol. 27, no. 6, pp. 1112–1116, 2014.
- [13] B. Lee and F. J. Harackiewicz, "Miniature Microstrip Antenna with A Partially Filled High-permittivity Substrate," *IEEE Trans. Antennas and Propag.*, vol. 50, no. 8, pp. 1160–1162, 2002.
- [14] F. Farzami, K. Forooghi and M. Noroozfar, "Miniaturization of A Microstrip Antenna Using A Compact And Thin Magneto-Dielectric Substrate," *IEEE Antennas and Wireless Propag. Lett.*, vol. 10, pp. 1540–1542, 2011.
- [15] L. Jofre, B. A. Cetiner and F. De Flaviis, "Miniature Multi-element Antenna for Wireless Communications," *IEEE Trans. Antennas and Propag.*, vol. 50, no. 5, pp. 658–669, 2002.
- [16] J. Anguera, C. Puente and J. Soler, "Miniature Monopole Antenna Based on the Fractal Hilbert Curve," in *IEEE Antennas and Propag. Soc. Int. Symp.*, vol. 4, pp. 546–549, 2002.

- [17] A. Holub and M. Polivka, "A Novel Microstrip Patch Antenna Miniaturization Technique: A Meanderly Folded Shorted-Patch Antenna," in *14th Conf. Microwave Techniques*, 2008.
- [18] M. Kim and H. Arai, "Low-Profile Loop-Shaped Inverted-F Wire Antenna with Dual-Mode Operation," *IEEE Antennas and Wireless Propag. Lett.*, vol. 7, pp. 62–65, 2008.
- [19] M. Secmen and A. Hizal, "An Inverted L-shape Fed Microstrip Patch Antenna for Mobile Communication," in *21st Annual IEEE Int. Symp. Personal, Indoor and Mobile Radio Communications*, 2010.
- [20] A. Khidre, K. F. Lee, F. Yang and A. Z. Elsherbeni, "Circular Polarization Reconfigurable Wideband E-Shaped Patch Antenna for Wireless Applications," *IEEE Trans. Antennas and Propag.*, vol. 61, no. 2, pp. 960–964, 2013.
- [21] S. Cui, Z. Z. Liu, Y. J. Hou, H. Zeng, Z. K. Yue and L. H. Liang, "Study on Efficiency of Different Topologies of Magnetic Coupled Resonant Wireless Charging System," *IOP Conf. Series: Earth and Environ. Sci.*, vol. 93, pp. 012064, 2017.
- [22] J. L. Volakis, *Antenna Engineering Handbook*, McGraw-Hill, New York, 2007.
- [23] K. Isa, Z. Md. Zain, R. M. Mokhtar, M. M. Noh, Z. H. Ismail, A. A. Yusof, A. F. M. Ayob, S. S. A. Ali, H. A. Kadir, in *Proceed. 12th Nat. Techn. Seminar on Unmanned Sys. Technol. 2020*, Springer Nature, 2021.